

T-4000 Series Pneumatic Room Thermostats

Features

- Adjustable Sensitivities and Set Points
- Individual Set Points on Dual Temperature Controllers
- Pneumatic Feedback for Greater Accuracy
- Vibration and Shock Resistant
- Meets Governmental and Commercial Requirements
- Single or Dual Bimetal Sensing Elements
- Element Identification Labels
- Rugged Construction and Decorative Design

The T-4000 Series Pneumatic Room Thermostats provide individual space temperature control in all types of heating and cooling applications. By producing a proportional output signal, these thermostats modulate controlled devices in response to load changes in the space. This imposes the least demand on mechanical heating and cooling apparatus. A variety of high volume output and low volume output controllers are available to meet the functional requirements of any control system. Auxiliary devices are available to perform functions such as two-position action, high-low pressure selection, sequencing, etc.

High Volume Output Thermostats

The high volume output thermostats feature pneumatic feedback and volume amplification to provide fast and accurate proportional response. All models feature an output test connection which can be used for service and calibration.

A variety of covers (see Page 3) and mounting accessories (see

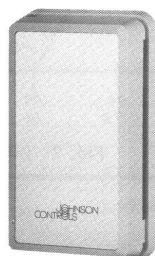

Typical Low Volume Output Thermostat

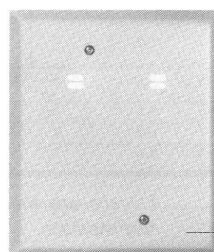

Concealed Mounted Thermostat

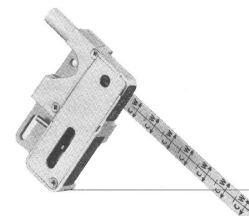

Typical Diffuser Mounted Thermostat

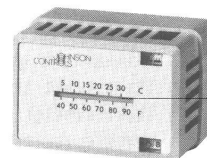

Typical High Volume Output Thermostat

Table 1) for horizontal and vertical mounting are available and must be ordered separately.

Model Descriptions

The **T-4002** is a single temperature thermostat available in direct and reverse acting models.

The **T-4003** submaster thermostat can be reset from a remote location or in accordance with a reference temperature variation. An increase in master pressure from a remote source will increase (direct readjustment) or decrease (reverse readjustment) the set point of the direct or reverse acting model respectively.

The **T-4054** energy manager heating-cooling room thermostat features an adjustable deadband of 0 to 30F° (0 to 16C°) between heating and cooling set points (see Fig. 1). This deadband encourages energy conservation and prevents

energy waste by eliminating heating and cooling overlap.

The **T-4506** is a dual temperature, dual dial thermostat designed to provide individual day and night or two set point temperature control. The set point change is accomplished with a change in supply pressure. A 15 PSIG (105 kPa) supply represents the lower element and a 20 PSIG (140 kPa) supply represents the upper element. The action of both elements is the same. A change in either set point does not affect the other set point. On day-night applications with 20 PSIG representing the night set point, an optional manual indexing switch is available to restore the day temperature of the individual thermostat without affecting the other system thermostats. The indexing switch can be unlatched manually or will automatically reset with the day cycle.

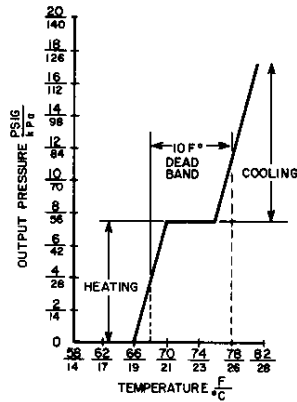

Fig. 1: T-4054 Operational Graph

The **T-4516** is also a dual temperature, dual dial thermostat for individual day and night control or weekend setback. Functionally it is similar to the T-4506; however, it features an additional output air terminal which can be used as an on-off switchline pressure. The manual indexing switch is standard on this thermostat. Depressing the switch exhausts the switchline pressure and restores day operation of the individual thermostat without affecting other system thermostats. The switch can be unlatched manually or will automatically reset with the day cycle.

The **T-4756** is a dual temperature, dual dial heating-cooling thermostat which accomplishes mode switchover between direct and reverse actions, with a change in supply pressure from 15 to 20 PSIG (105 to 140 kPa). An energy conservation model is available with factory stops to limit the set points to 75°F (24°C) maximum for heating and 75°F minimum for cooling. This model is furnished with WARM and COOL dials.

Low Volume Output Thermostats

The low volume output thermostats employ a ball type, force balance control port to provide proportional feedback and stable control. These thermostats are electrically non-conductive and allow test probe access without removal of the cover. Attractive low profile

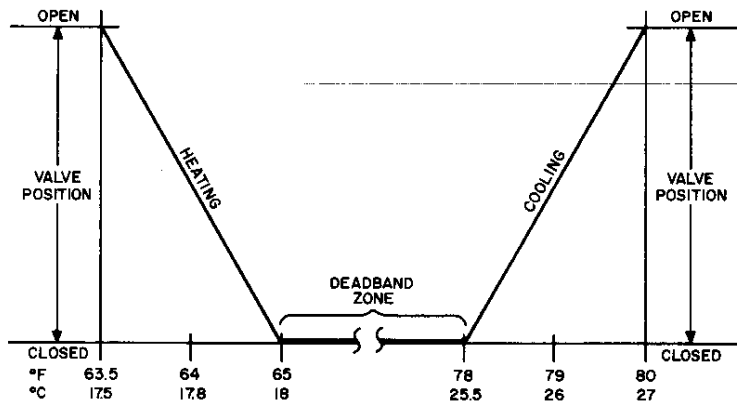

Fig. 2: T-4600 Operational Graph

covers are included with these thermostats.

Model Descriptions

The **T-4100** is a single temperature thermostat. The unit features exposed or concealed set point adjustment and a standard Fahrenheit and Celsius thermometer. With the use of a remote restrictor, this instrument requires only one air connection.

The **T-4110** is a single temperature thermostat designed specifically for mounting in ceiling terminal units. This thermostat may be located within a room air sampling chamber, return air grille, or is available with an optional protective cover which incorporates an aspirator feature to be powered by the duct air pressure when mounted in a diffuser. Available in direct or reverse models, the unit features a long flexible plastic lever, connected to its set point adjuster, which extends through the ceiling or diffuser allowing adjustment from inside a room.

The **T-4600** is an energy manager heating-cooling thermostat which features two outputs and individually adjustable sensitivities and set points for heating and cooling. Available in dual direct, dual reverse, or direct and reverse action models, the independent set points can result in a deadband to encourage energy conservation and prevent energy waste by eliminating heating and cooling overlap (see Fig. 2).

Note: All dual temperature thermostats come equipped with element identification labels indicating the function of the element.

Installation

Thermostat installation procedures vary between the high volume output and low volume output units. Various accessories are available (see Table 1) to facilitate mounting room thermostats on virtually any wall surface. For a complete list of accessory repair parts, refer to Installation Data T-4000-A.8.

All thermostats can be mounted horizontally or vertically; air connections are made with 5/32 in. O.D. polytubing to barbed fittings furnished on the units. Only high volume output thermostats that do not have manual indexing switches can be concealed mounted with the use of an aspirator wallbox and flush wallplate. Other accessories can be used for ceiling suspended mounting. Several kits are also available for converting existing thermostats. For complete mounting instructions, refer to Installation Data T-4000-A.

Adjustment

The procedure for set point and sensitivity adjustment depends on the type of thermostat and method of mounting. For detailed adjusting instructions, refer to Adjustment Data T-4000-B.

Application and Drawing Identification

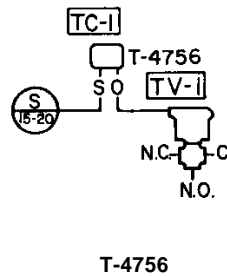
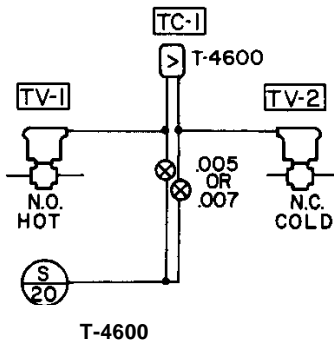
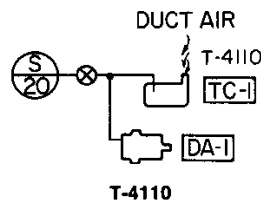
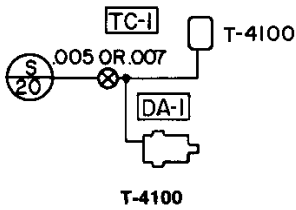
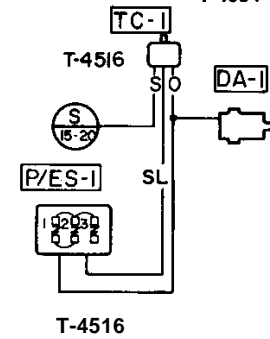
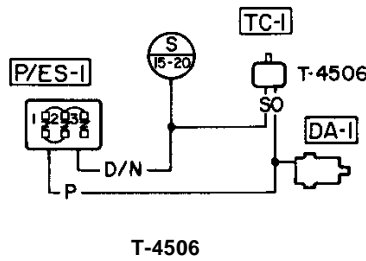
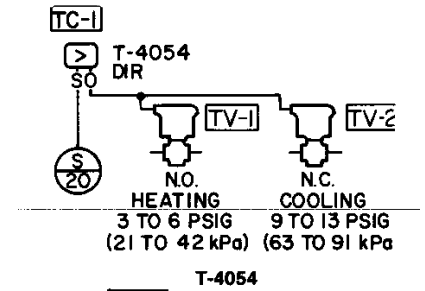
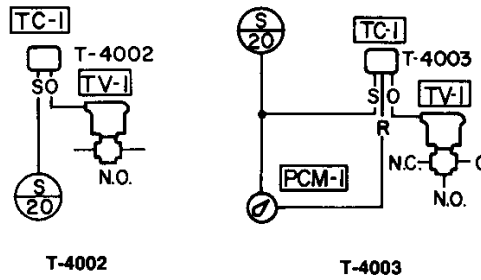
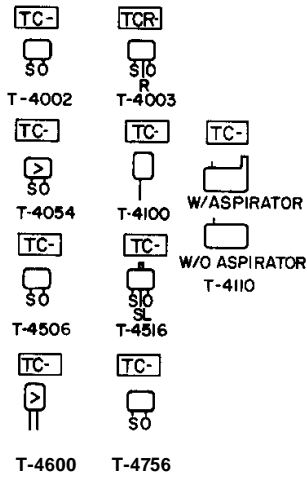

Beige Plastic Cover Selection Guide for High Volume Output Thermostats

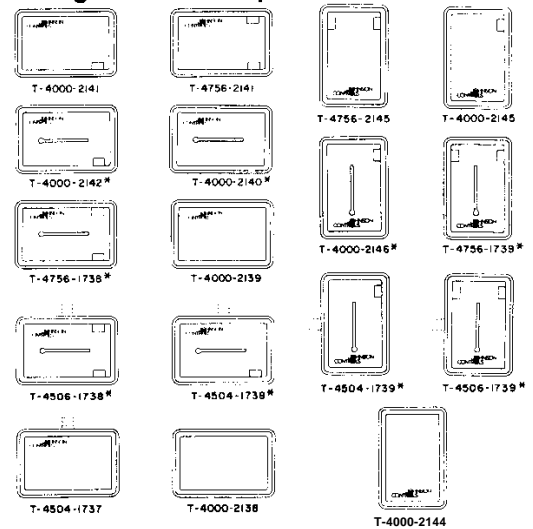

* Covers with Thermometers have both °F and °C scales.

Thermostat Specification and Selection Guide (table rows continued on facing page)

	Type	Action-Proportional	Sensitivity	Flow Capacity	Air Consumption	Supply Pressure *
T-4002	Single Temperature	Direct or Reverse	Adjustable from .75 to 4 PSI/F° (9 to 50 kPa/C°) Factory set at approx. 2.5 PSI/ F° (32 kPa/C°)	400 SCIM (107 mL/s)	20 SCIM (5 mL/s)	13 to 25 PSIG (91 to 175 kPa) Nominal 20 PSIG (140 kPa)
T-4003	Submaster	Direct-Direct Readjustment Reverse--Reverse Readjustment	Fixed at approx. 2.5 PSI/ F° (32 kPa/C°)	400 SCIM (107 mL/s)	20 SCIM (5 mL/s)	Supply Pressure: 13 to 25 PSIG (91 to 175 kPa) Nominal 20 PSIG (140 kPa) Master Pressure: Variable input 0 to 20 PSIG (0 to 140 kPa)
T-4054	Dual Temperature Heating/ Cooling	Direct or Reverse	Adjustable from 1 to 3 PSI/F° (12 to 38 kPa/C°), Factory set at approx. 2.5 PSI/ F° (32 kPa/C°)	400 SCIM (107 mL/s)	38 SCIM (10 mL/s)	13 to 25 PSIG (91 to 175 kPa) Nominal 20 PSIG (140 kPa)
T-4100	Single Temperature	Direct or Reverse	Adjustable from 1 to 3 PSI/F° (12 to 38 kPa/C°), Factory set at approx. 2.5 PSI/ F° (32 kPa/C°)	45 SCIM (12 mL/s) with .007 in. Restrictor, 25 SCIM (7 mL/s) with .005 in. Restrictor	45 or 25 SCIM (12 or 7 mL/s) Depending on Restrictor	13 to 25 PSIG (91 to 175 kPa) Nominal 20 PSIG (140 kPa) restricted
T-4110	Single Temperature	Direct or Reverse	Adjustable from 1 to 3 PSI/F° (12 to 38 kPa/C°), Factory set at approx. 2.5 PSI/ F° (32 kPa/C°)	45 SCIM (12 mL/s) with .007 in. Restrictor, 25 SCIM (7 mL/s) with .005 in. Restrictor	45 or 25 SCIM (12 or 7 mL/s) depending on restrictor	13 to 25 PSIG (91 to 175 kPa) Nominal 20 PSIG (140 kPa) restricted
T-4506	Dual Temperature Day/Night Switched Supply	Dual Direct or Dual Reverse with Auto Switchover at 17 PSIG (119 kPa)	Adjustable from .75 to 4 PSI/F° (9 to 50 kPa/C°) Factory set at approx. 2.5 PSI/ F° (32 kPa/C°)	400 SCIM (107 mL/s)	20 SCIM (5 mL/s)	13 to 25 PSIG (91 to 175 kPa), Nominal Day: 15 PSIG (105 kPa) Nominal Night: 20 PSIG (140 kPa)
T-4516	Dual Temperature Day/Night Switched Supply and Switchline	Dual Direct with Auto Switchover at 17 PSIG	Adjustable from .75 to 4 PSI/F° (9 to 50 kPa/C°) Factory set at approx. 2.5 PSI/ F° (32 kPa/C°)	400 SCIM (107 mL/s)	20 SCIM (5 mL/s)	Supply Pressure (nominal): 15 PSIG (105 kPa) 20 PSIG (140 kPa) Switchline Pressure (nominal): 0 PSIG (0 kPa) 20 PSIG (140 kPa)
T-4600	Dual Temperature Heating/ Cooling	Dual Direct, Dual Reverse, or Direct/Reverse	Adjustable from 1 to 3 PSI/F° (12 to 38 kPa/C°) Factory set at approx. 2.5 PSI/ F° (32 kPa/C°)	45 SCIM (12 mL/s) with .007 in. Restrictor 25 SCIM (7 mL/s) with .005 in. Restrictor (for each output)	50 or 90 SCIM (14 or 24 mL/s) Depending on Restrictors	13 to 25 PSIG (91 to 175 kPa) Nominal 20 PSIG (140 kPa) restricted
T-4756	Dual Temperature Heating/ Cooling Switched Supply	Direct/Reverse	Adjustable from .75 to 4 PSI/F° (9 to 50 kPa/C°) Factory set at approx. 2.5 PSI/ F° (32 kPa/C°)	400 SCIM (107 mL/s)	20 SCIM (5 mL/s)	13 to 25 PSIG (91 to 175 kPa) Nominal 15 PSIG (105 kPa) Direct, 20 PSIG (140 kPa) Reverse, or Vice Versa

Thermostat Specification and Selection Guide (table rows continued from facing page)

	Air Connections**	Dial Ranges	Special Features	Code No.	Suffix	Shipping Weight lb.***
T-4002	Two Supply and Output	55 to 85° F	Volume Amplifier, Pneumatic Feedback	T-4002-	Action Vert. Horiz DIR 201 203 REV 202 204	0.4
T-4003	Three Supply, Output, and Remote Reset Input	55 to 85° F	Volume Amplifier, Remote Readjustment--from .15 to 2.5°F/PSI (1.8 to 30°C/kPa)	T-4003-	Horiz DIR,DR 201 Horiz. REV,RR 203 Mtg.	0.4
T-4054	Two Supply and Output	Two dials 55 to 85° F	Energy Manager, Pneumatic Feedback, Adjustable Deadband--between 5 and 12 PSIG (35 and 84 kPa)	T-4054-	Horiz or Vert. DIR 1 REV 2	0.4
T-4100	One Restricted Supply/Output	55 to 85°F or 13 to 29°F	Pneumatic Feedback, °F and °C Thermometer	T-4100- (Vert. Mtg.)	F° Dial C° Dial DIR 1 3 REV 2 4	0.2
T-4110	Two Control and Aspirator	66 to 82°F (19 to 28°C)	Ball Control Port , Flexible Setpoint, Lever, Adjustable Sensitivity	T-4110-	w/o aspirator w/aspirator DIR 1 2 REV 3 4	0.2
T-4506	Two Supply and Output	Two dials 55 to 85°F	Volume Amplifier, Pneumatic Feedback, Manual Indexing Switch (optional), Element Identification Labels	T-4506-	mtg. w/switch w/o switch DIR Horiz. 201 203 Vert. 202 204 REV Horiz. 209 217	0.4
T-4516	Three Supply, Output, and Switchline	Two dials 55 to 85°F	Volume Amplifier, Pneumatic Feedback, Manual Indexing Switch (standard), Element Identification Labels	T-4516-	DIR Horiz. 201 Vert. 202	0.4
T-4600	Two-Restricted Supply/Output for Heating and Cooling	50 to 80°F and 63 to 93°F or 10 to 27°C and 17 to 34°C	Energy Manager, Individual Adjustments for Heating and Cooling, Element Identification Labels	T-4600- (Vert. Mtg.)	Action F° Dial C° Dial DIR 1 3 REV 2 4 DIR and REV 5 6	0.3
T-4756	Two Supply and Output	Two dials 55 to 85°F	Volume Amplifier, Models Available with Factory Stops and WARM-COOL dials, Element Identification Labels	T-4756-	Action Mtg. F° Dial W-C Dial DIR Horiz. 201 216 @15 PSIG Vert. 202 DIR Horiz. 205 217 @20 PSIG Vert. 206	0.4

Elements

***Supply Pressure**

****Air Connections**

Ambient Operating Temp Limits

Ambient Storage Temp Limits

*****lb x 0.454 = kg**

Single or Dual Bimetal Strips

Air Supply Must Be Clean, Dry, and Oil Free

Barbed Fittings for 5/32 in. O.D. Polytubing

-20 to 130°F (-29 to 54°C)

-20 to 150°F (-29 to 66°C) or -20 to 130°F for Units with Thermometers

The performance specifications are nominal and conform to acceptable industry standards. For application at conditions beyond these specifications, consult the local Johnson Controls office. Johnson Controls, Inc. shall not be liable for damages resulting from misapplication or misuse of its products.

Table 1: Accessories (Order Separately)

Thermostat, Mounting or Air Connection Accessory Description	Application		Shipping Weight lb*	Code Number	Function	
	High Volume	Low Volume				
Room Instrument Mounting Bracket	X		0.3	T-4002-124	For surface mounting all thermostats and covers	
Plaster Groundplate	X		0.2	T-4002-6038	For rough-in of surface mounted thermostats in masonry	
Metal Wallbox	X	X	0.3	T-4002-6029		
Cover for Groundplate or Metal Wallbox	X	X	0.2	T-4002-5010	To keep dirt out of ground-plate and wallbox during construction	
Restricted Adjustment Pin (Order in Multiples of 100)	X	X	0.2	T-4002-5003	To restrict adjustment of set point dial	
Universal Wallplate Adapter Kit		X	0.1	T-4100-103	Mounts on standard electrical wallboxes and some competitor's hardware	
Plastic Screw Anchors (Order in Multiples of 100)	X	X	0.5	F-1000-321	For mounting brackets and wallboxes	
Wire Guard	For Exposed Tubing	X	X	0.3	T-4002-3000	For surface mounted thermostat protection after construction
	For Concealed Tubing	X	X	0.3	T-4002-3001	
Optional Wire Guard Mounting Plate	X	X	0.2	T-4002-6045		
Cast Aluminum Guard and Mounting Bracket	X	X	0.3	T-4002-3004		
Plastic Guard	X	X	0.4	GRD10A-608		
Concealed Thermometer	X		.01	T-4000-108	For concealed thermometer cover applications	
Plastic Surface Mounting Back	X		0.5	T-4002-125	For surface mounted thermostats with exposed tubing	
Terminal Connector with Two Angle Fittings	X		0.1	T-4002-123		
Aspirator Wallbox Kit	X		0.5	T-4000-110	For concealed mounted thermostats without pushbuttons	
Wallplate Cover Kit	Beige Finish	X	0.4	T-4000-111		
	Stainless Steel Finish	X	0.4	T-4000-112		
Two-Tube Sheathed Polyethylene Strain Relief Bushing	X	X	0.1	T-4000-101	For rough-in box or metal wallbox to instrument air system tubing adaptation (1/2 in. knockout)	
Three-Tube Sheathed Polyethylene Strain Relief Bushing	X		0.1	T-4000-102		
1/2 in. Conduit (EMT) Connector	X	X	0.1	T-4000-103		
Set Point Label Card	X	X	0.1	T-4000-114	To identify the control function	
Wallbox Mounting Kit	X		0.2	TE-1800-9600	To adapt 4000 series brackets and covers to standard conduit wallboxes	
Terminal Connector with Two Straight Fittings	X		0.1	T-4002-122	For optional plug-in connection to 5/32 in. O.D. polyethylene tubing	
Terminal Connector with Three Straight Fittings	X		0.1	T-4512-100		
Terminal Connector Protector Cap (For Rough-in Only)	X		0.1	T-4000-100		
Two 5/32 x 5/32 in. Elbow Fittings		X	0.1	F-500-45		
Ceiling Suspended Mounting Kit (See T-4000-A Bulletin)	X		0.5	T-4002-100	To provide a method of installing a 4000 series thermostat other than wall mounting	
Adjusting Knob Kit	X		0.5	T-4002-5012	To provide a means of external set point adjustment	
0 to 150°F Dial Strip (Select 30°F Span for Special Range)	Horizontal	Lower	X	0.5	T-4000-115	To provide dial ranges other than the standard ranges
		Upper	X	0.5	T-4506-100	
	Vertical	Right	X	0.5	T-4000-116	
		Left	X	0.5	T-4506-101	
-20 to 80°C Dial Strip (Select 15°C Span for Special Range)	Horizontal	Lower	X	0.5	T-4000-117	
		Upper	X	0.5	T-4506-102	
	Vertical	Right	X	0.5	T-4000-118	
Left		X	0.5	T-4506-103		
Plain Faceplate Kit		X	0.1	T-4100-100	For T-4100 and T-4600 series thermostat covers	
Horizontal Faceplate Kit		X	0.1	T-4100-101		
Thermometer: °F and °C		X	0.1	T-4100-102		
Restrictor - .005 in. (Red)		X	0.1	R-3710-1005	For restricted supply source	
Restrictor - .007 in. (Aqua)		X	0.1	R-3710-1007		
Restrictor Tee - .005 in. 1/4 x 5/32 (Red)		X	0.1	R-3710-3205		
Restrictor Tee - .007 in. 1/4 x 5/32 (Aqua)		X	0.1	R-3710-3207		
Hypodermic Needle Test Probe	X	X	0.2	X-200-140	Calibration	
Screw-in Gage	X		0.3	X-200-19		

*lb x 0.454 = kg

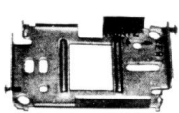

T-4002-124



F-1000-321

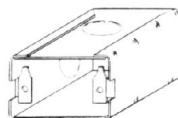

T-4002-6029

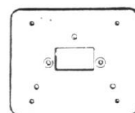

T-4002-6045



T-4002-5010



T-4002-125

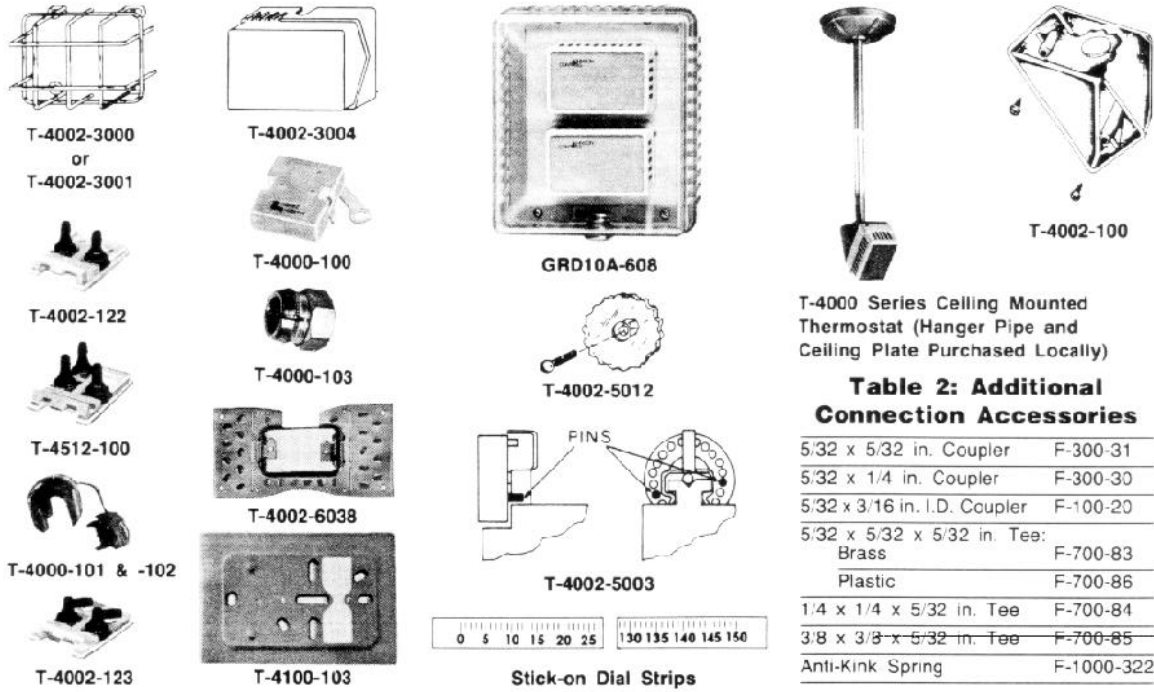

T-4000 Series Ceiling Mounted Thermostat (Hanger Pipe and Ceiling Plate Purchased Locally)

Table 2: Additional Connection Accessories

5/32 x 5/32 in. Coupler	F-300-31
5/32 x 1/4 in. Coupler	F-300-30
5/32 x 3/16 in. I.D. Coupler	F-100-20
5/32 x 5/32 x 5/32 in. Tee:	
Brass	F-700-83
Plastic	F-700-86
1/4 x 1/4 x 5/32 in. Tee	F-700-84
3/8 x 3/8 x 5/32 in. Tee	F-700-85
Anti-Kink Spring	F-1000-322

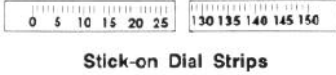

Stick-on Dial Strips

Dimensions $\frac{\text{in.}}{\text{mm}}$

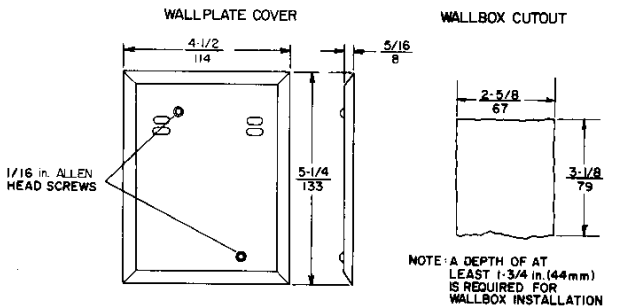

Concealed Mounted Thermostat Wallplate and Wallbox Cutout

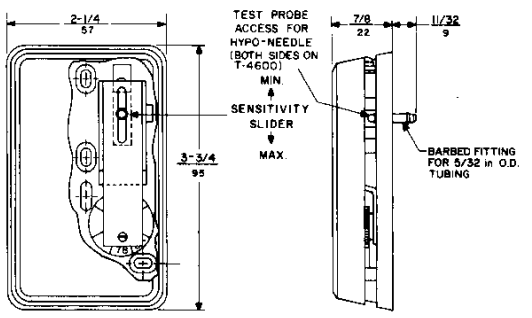

Low Volume Output Thermostat

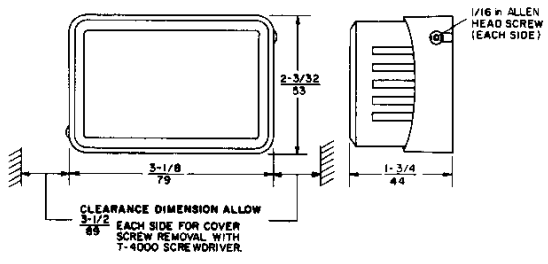

High Volume Output Thermostat

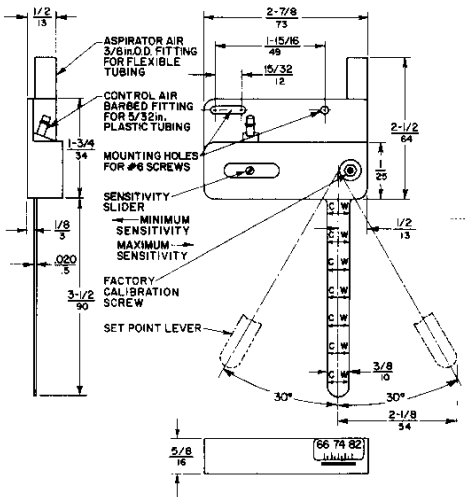

Diffuser Mounted Thermostat

Notes

JOHNSON
CONTROLS

Controls Group
507 E. Michigan Street
P.O. Box 423
Milwaukee, WI 53202

Printed in U.S.A.